

# PP-TA2

## Installation Guide

Truss Mount for 290mm / 11.42" to 304.8mm /  
12.00" Truss W/ 2.0" Outer Diameter Tubing

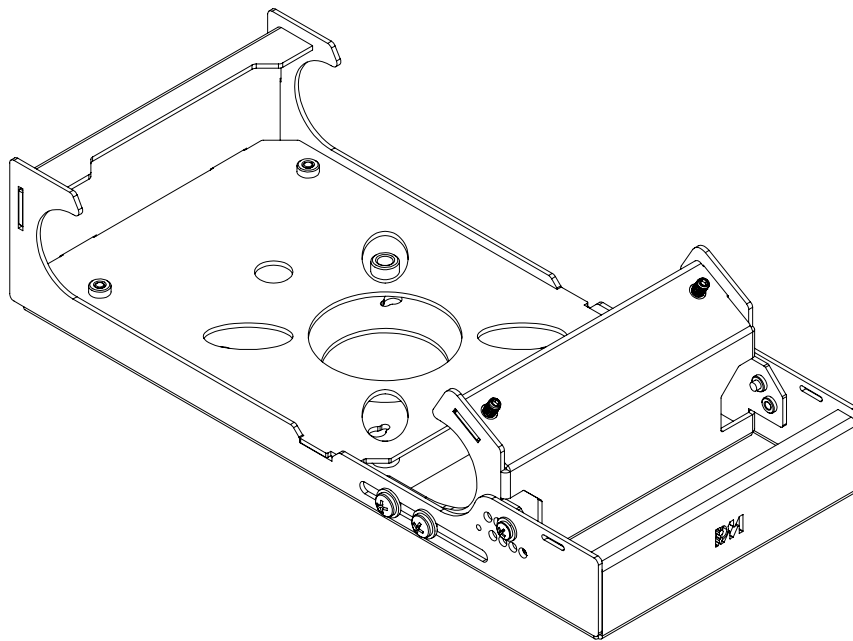

INST-1324 REV A



**INCLUDES**

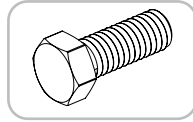
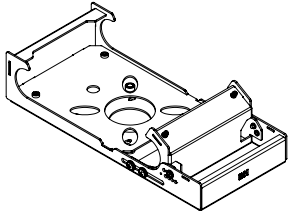

3/8 X 3/4" Hex Bolt (Qty 4)

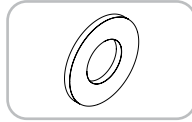

3/8" Flat Washer (Qty 4)

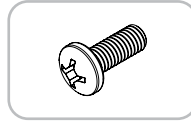

#10-32 X 1/2" (Qty 4)



#10-32 Flat Washer (Qty 4)

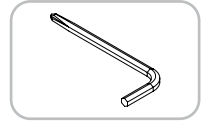

1/8" Hex Key (Qty 1)

**FEATURES**

**Max Display Weight:**  
200 lbs / 90.7 kg

Compatibility	Horizontal	Vertical	Overhead
CTM-MS1, CTM-MS2, CTM-MS3*, PFD2, PTDM2,	✓	✓	
PP-5, PP-5A, PP-6, PP-6A, AST-1321, AST-2446, PBC-UMS, PBC-UMW, PBL-UMS, PBL-UMW, PBM-UNI			✓
Display Panel (75X75), UFP-280B, UFP-400	✓	✓	
SYM-IB-XXX (Symmetry Interface Bar)*	✓		

\*Requires two PP-TA2 for mounting in horizontal position

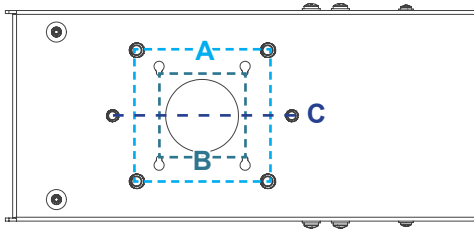

Letter	Bolt Pattern	Application
<b>A</b>	4.5 X 4.5 in	Wall Mounts / Ceiling Mounts
<b>B</b>	75 X 75 mm	Display Panel / Display Adapters
<b>C</b>	6.15" / 156mm	Symmetry Interface Bar

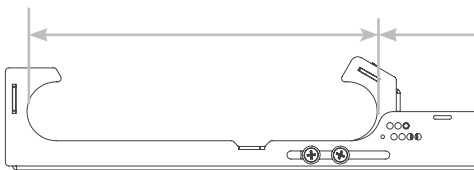

For truss 290mm (11.42") to 304.8mm (12.00") with 50mm (2.00") outer diameter.

**SUITABLE MOUNTING POSITIONS**

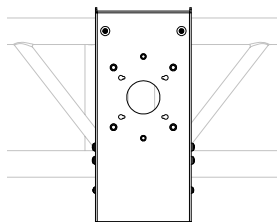

**Horizontal**

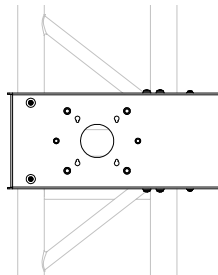

**Vertical**

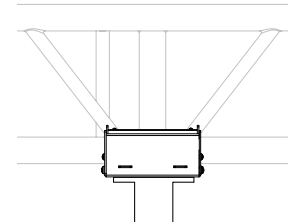

**Overhead (hanging)**



1 Open the clamp before mounting it to the truss.

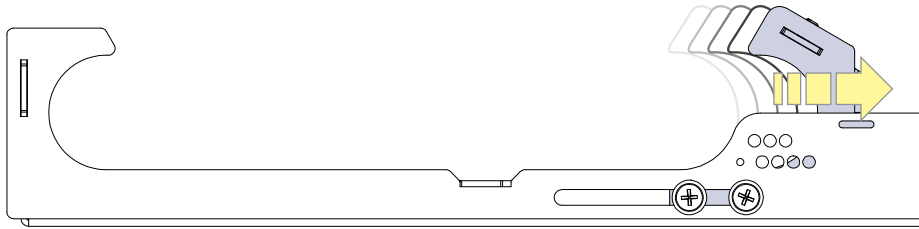

2

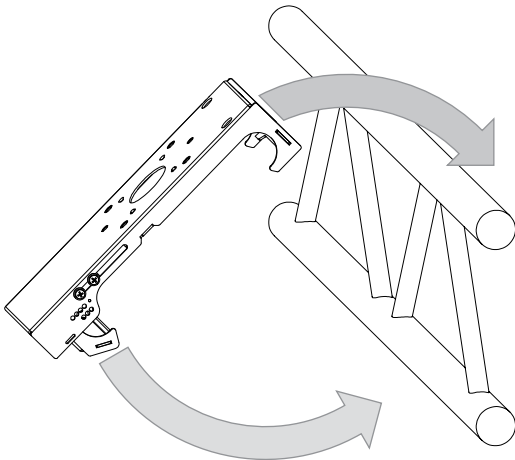

Place the hooks of the Truss Mount onto the truss tube.

3

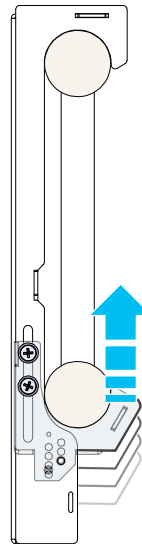

Push the clamp together and line up the mounting holes. Lock the clamp in place using (1) #10-32 screws and washer per side.

Various mounting holes for 11.42" (290mm) to 12.00" (304.8mm) truss with micro-adjust.

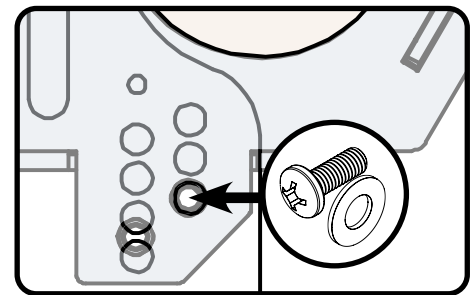

4

1. The set screws need to be securely tightened to engage with the truss, ensuring additional safety, particularly when mounted vertically.
2. Tighten until there is surface contact, then turn an additional **half turn**.
3. **Do not overtighten.**

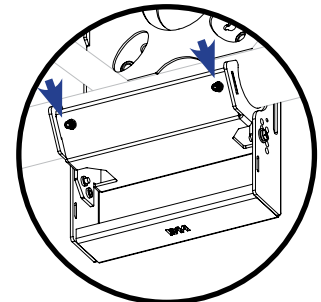
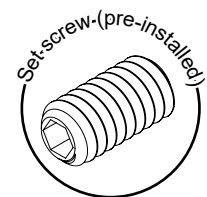
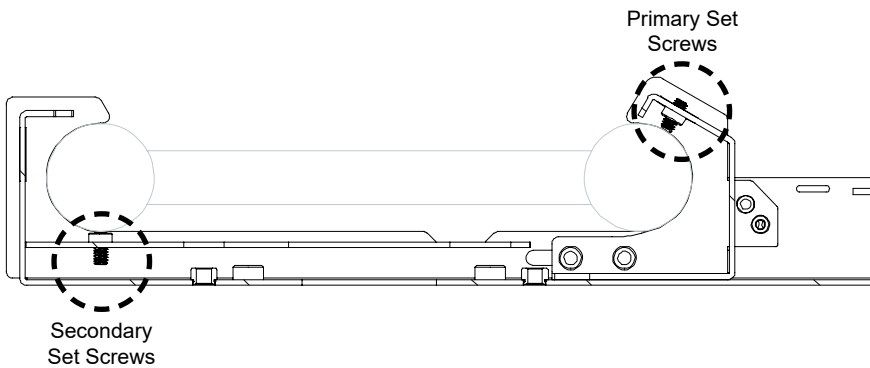

Use four 3/8-16 hex bolts and washers to secure any compatible mount that has a 4.5" X 4.5" bolt pattern.

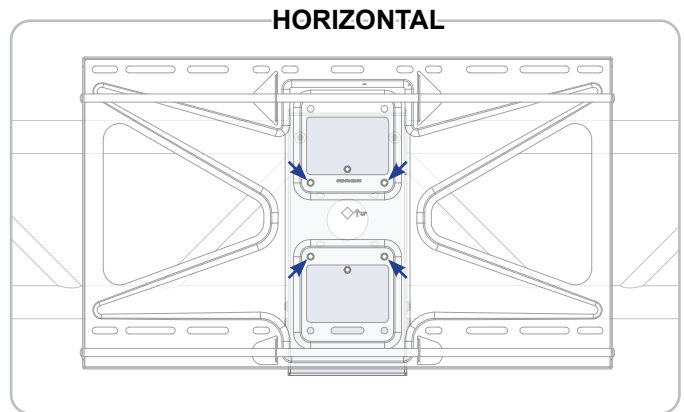
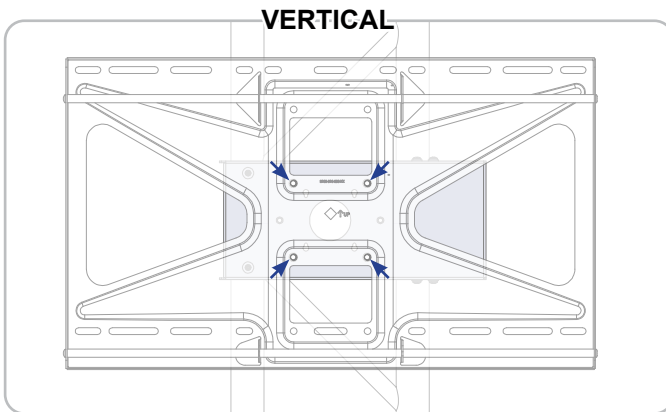
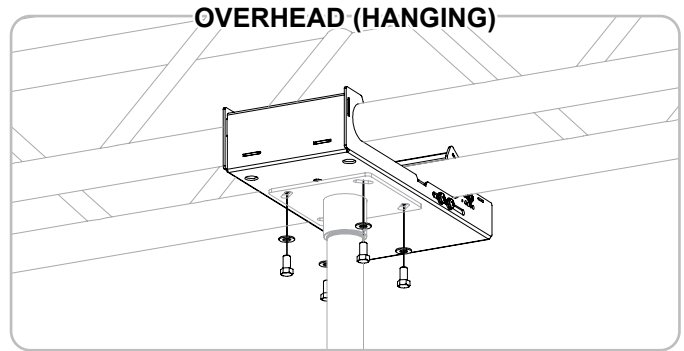
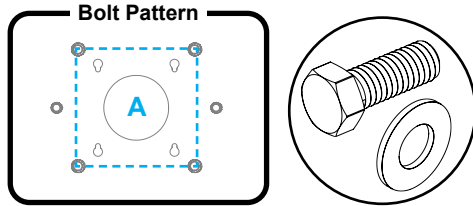

Any display panel with a VESA 75 X 75 can be mounted directly to the truss mount or with a VESA adapter plate to extend the VESA.

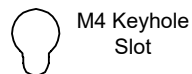

Max Display Weight:  
 50 lbs / 22.6 kg

**UFP-280B**  
 100X100, 100X200,  
 200X200



**UFP-400**  
 100X100, 300X300,  
 400X400

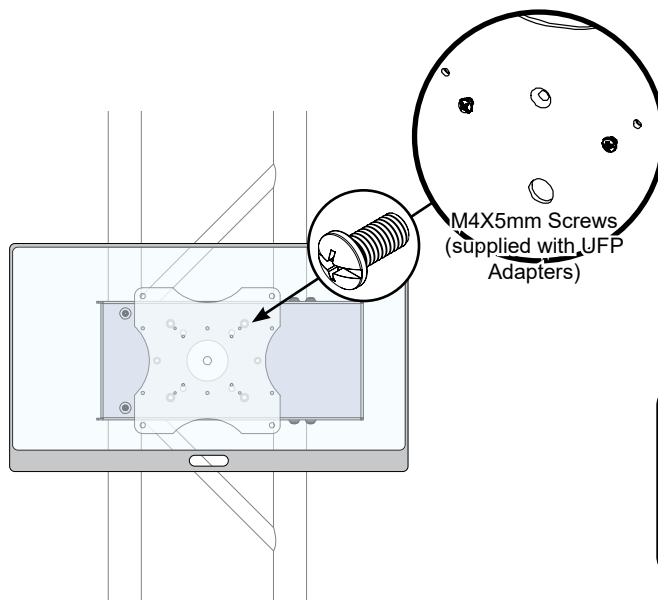
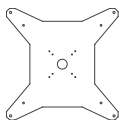

M4X5mm Screws  
 (Supplied with UFP  
 Adapters)

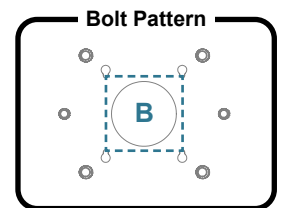

When using CTM-MS3 or Symmetry Interface Bars, use two truss mounts for structural stability and increased weight capacity.

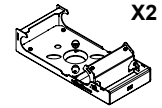

Max Display Weight:  
300 lbs / 136 kg

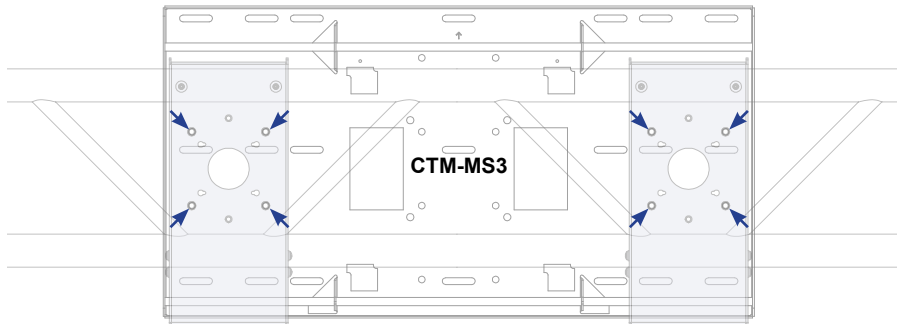

Figure 1

Note: CTM-MS3 can be mounted in the middle using a single truss mount for a display panel weighing 160 lbs / 72.5 kg or less.

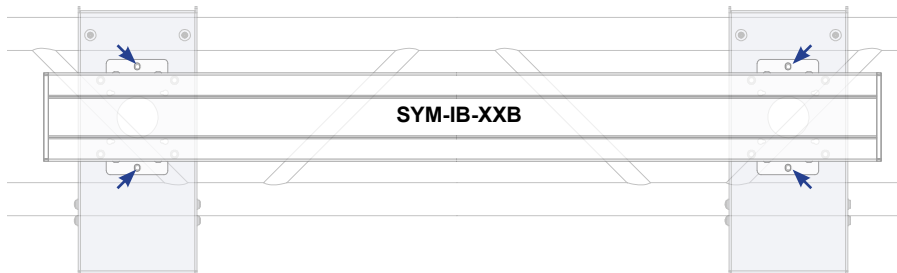
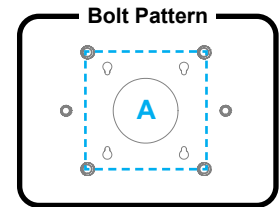
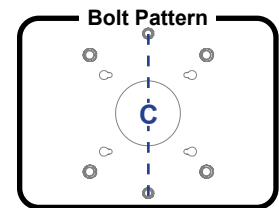

Figure 2

Use existing M8 hardware (included with SYM-IB-XXX) to attach the symmetry interface bracket to the truss mount.



**Premier Mounts Office**

**A** 500 W Central Ave, STE A  
Brea, CA 92821, USA

**P** 1-800-368-9700

**E** orders@premiermounts.com

**W** premiermounts.com



**Gamber-Johnson World HQ**

**A** 5001 Joerns DR  
Stevens Point, WI 54481, USA

**P** 1-715-344-3482

**F** 1-715-344-5209

**W** gamberjohnson.com

