

THE INFORMATION CONTAINED IN THIS DRAWING IS THE SOLE PROPERTY OF PREMIER MOUNTS DIVISION OF <PMPI> ANY REPRODUCTION IN PART OR WHOLE WITHOUT THE WRITTEN PERMISSION OF PREMIER MOUNTS DIVISION OF <PMPI> IS PROHIBITED.

SYM-IB-11B
176 lbs

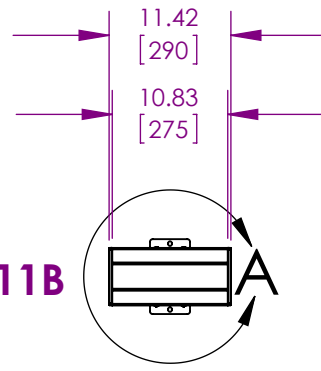

SYM-IB-28B
176 lbs

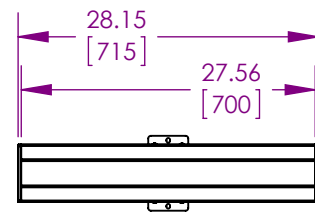

SYM-IB-36B
176 lbs

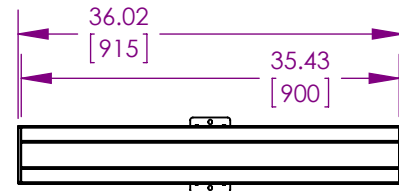

SYM-IB-75B
353 lbs

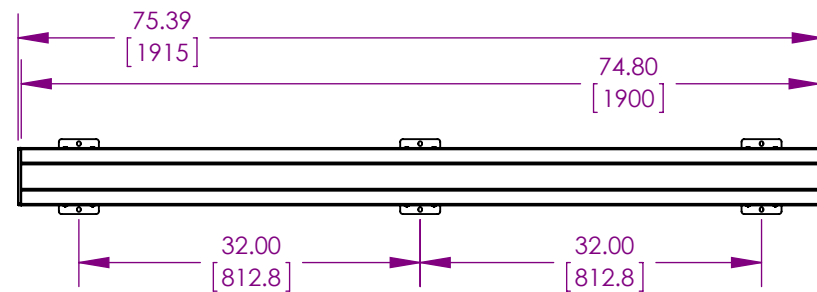

SYM-IB-108B
353 lbs

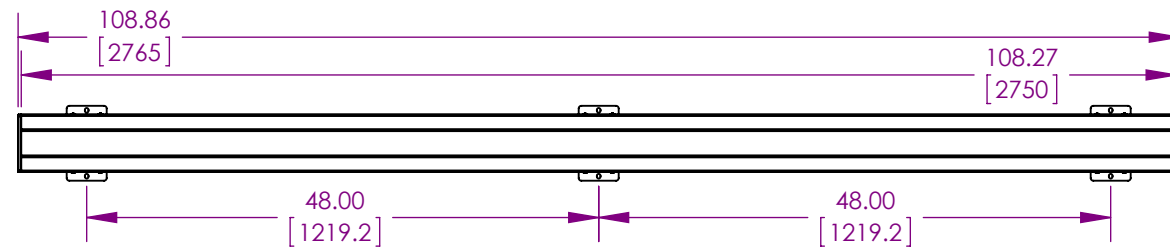

SYM-IB-130B
353 lbs

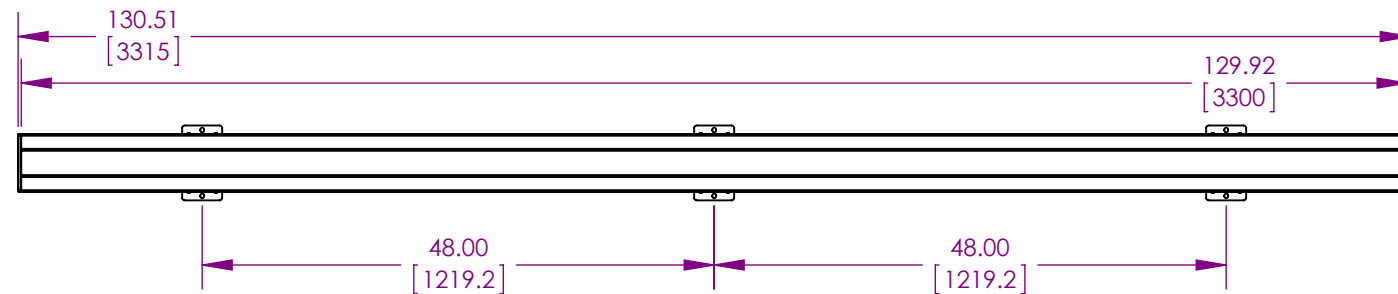

WALL MOUNTING BRACKET
NOTE: WALL MOUNTING BRACKET IS STANDARD TO ALL BAR LENGTHS

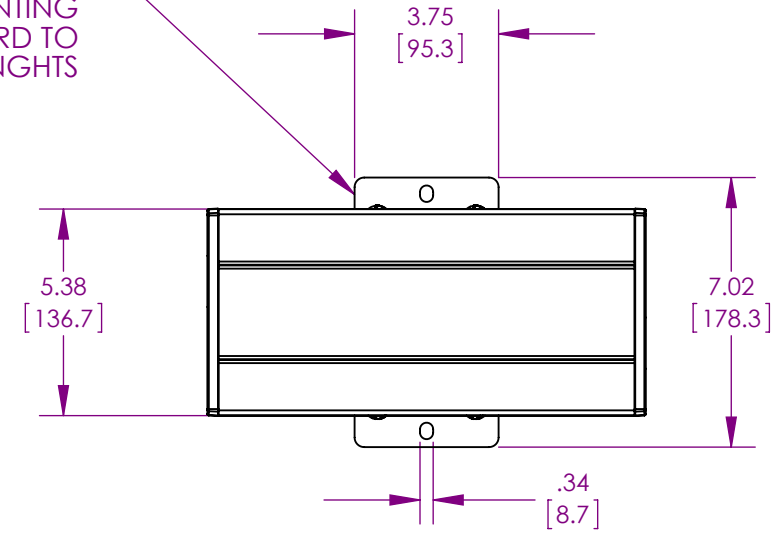

DETAIL A
SCALE 1 : 5

